

ZhuZhu AQUARIUM

AGE GRADE 4+

This package includes:

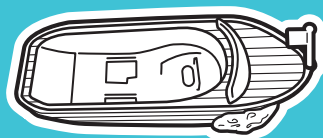

1 SPEEDBOAT

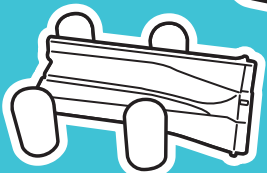

1 DOCK



1 RAMP

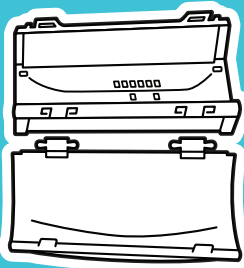

1 TUNNEL (TWO PARTS)



1 CONNECTOR

Unpacking your Zhu Zhu Aquarium™ Speedboat & Dock

Remove all contents from package and discard any rubber bands, wire ties or other packaging materials that are not part of the product.

Please Note

- Retain these instructions as they contain important information.
- Read all of the instructions before assembling your Speedboat & Dock.
- Some adult assembly is required.
- The ZhuZhu Aquarium™ Speedboat & Dock is a toy. It is not intended for use with live animals or in water.

The Speedboat & Dock are made to be used with Zhu Zhu Aquarium™ Fish which are sold separately. The Speedboat & Dock works best on an open floor.

For more information on the Zhu Zhu Aquarium™ and other aquarium add-on sets and accessories please go to:

www.zhuzhuaquarium.com

1

2

Assembling the Flag

Attach the flag to the front of the Speedboat by pressing the flag pole into the "D" shaped hole on the front of the boat as shown. **NOTE:** the flag faces to the rear of the boat and the pole is keyed to fit the hole snugly.

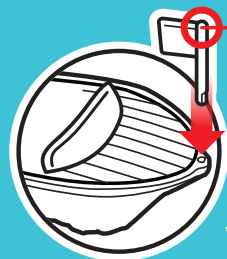

Two Ways to Play

The Speedboat & Dock can be used as standalone items or with the Ramp & Tunnel, and connect to other play sets from the world of Zhu Zhu Aquarium™.

In either case, Fish will swim across the Dock, board the Speedboat, and Zhu-oom off to a day of aquatic fun.

1. Using Speedboat with Dock

- A. Attach the Ramp to the back of the dock. Start at the top and snap the ramp down into place.

3

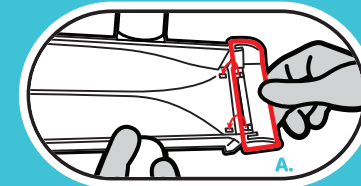

- B. Align the back of the Speedboat up with the front edge of the Dock.

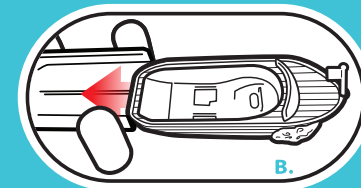

- C. Position Fish to swim up the Ramp and off the Dock into the Speedboat (Fish will **NOT** make specific boat noises and actions without going through the Tunnel first).

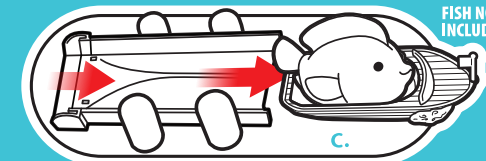

FISH NOT INCLUDED

4

• FISH SOLD SEPARATELY!

- DO NOT PUT FISH IN WATER!
- KEEP HAIR AWAY FROM WHEELS!

For Questions and Comments please call: 1-800-225-9319

©2023 Cepia LLC.
St. Louis, Missouri 63124
Made in China

WARNING:
CHOKING HAZARD - Small parts
Not for Children Under 3 Years



Complies with
Toy Safety
Standard
ASTM F963

Please Recycle

WARNING:

All rubber bands and wire ties, as well as tags, are not parts of this toy and should be discarded for your child's safety. Colors and contents may vary from those shown on the package.

Printed in China
REV T12102009 86650

8

2. Using Speedboat & Dock with Tunnel

- A. Attach the Ramp to the opening of the Tunnel **before** the engraved message: **TO BOAT** →. Start at the top and snap the Ramp down into place.

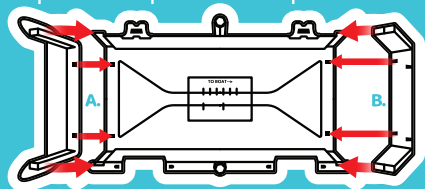

- B. Attach the Connector to the opening of the Tunnel **after** the engraved message: **TO BOAT** →. Start at the top and snap the Ramp down into place.

- C. Similarly, attach the Dock to the open side of the Connector by starting at the top and snap the Ramp down into place.

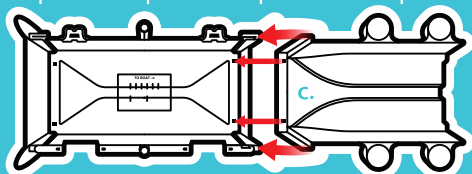

5

- D. To attach the Tunnel top, press one post on the Tunnel top into the hinge notch on the matching Tunnel base. Snap in the other post.

- E. Close the Tunnel top, noting how the other side of the top snaps into place.

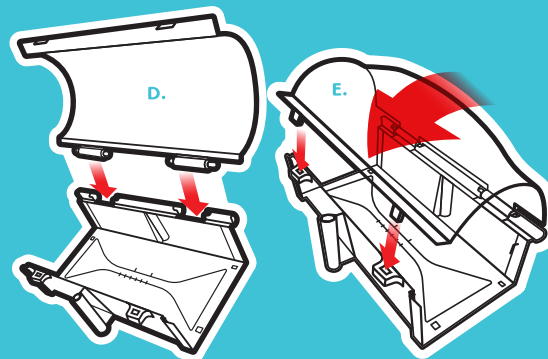

- F. Putting it all together. **NOTE:** Fish will not make specific boat noises and actions without going through the Tunnel via the same direction of the engraved message.

6

Troubleshooting

- Designed to act randomly and unpredictably, Fish may not act the same each time.
- If Fish gets stuck entering the Speedboat and Dock, check all the snaps and connector junctions. Be sure the boat is snugly located against the lead edge of the dock.
- Your pet works best on smooth, hard, even surfaces. It will not work in water, carpet, or other soft surfaces. Do not use in sand or grass.
- The Speedboat works best outside the track and other open surfaces.
- If Fish does not move on the Speedboat, make sure the wheels are still lined up with the openings towards the back of the boat.

Disassembly

Removing U-connectors, gently pull apart from the bottom.

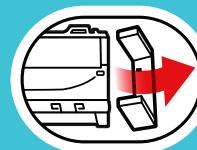

7